

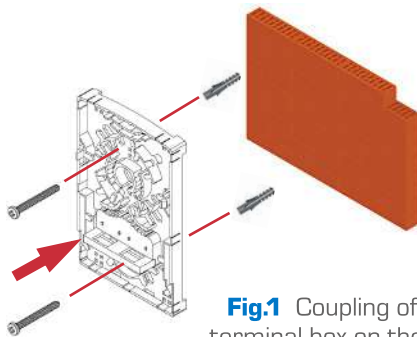
## PRODUCT INSTALLATION

### FIRST STEP - WALL INSTALLATION / WALL OUTLET TERMINAL BOX

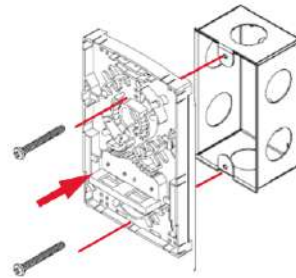
Identify both holes on the base of the terminal box and place the screws depending on the installation mode:

Wall: Use 2 #8 screws with the dowels.

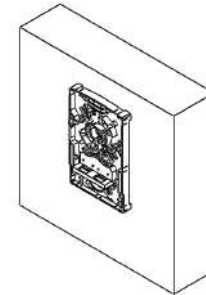
Wall outlet: Use 2 #6 screws



**Fig.1** Coupling of the terminal box on the wall.



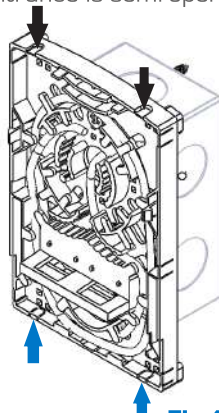
**Fig.2** Coupling of the terminal box on the wall outlet.



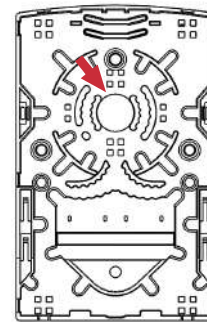
**Fig.3** Final position of the terminal box on the wall / wall outlet.

### SECOND STEP - INSERTION OF THE DROP CABLE TO TERMINAL BOX

Select one of the 3 entrances ways for fiber optic cable (Superior (black), central (red), inferior (blue)), every entrance is semi-open to make the installation easier:



**Fig.4** Location of the possible entrances for the cable installation (2 Inferior (blue), central (red) and 2 superior (black))



If it is necessary to make the insertion of the drop cable in any semi-perforated entrance, remove the entrance protection.

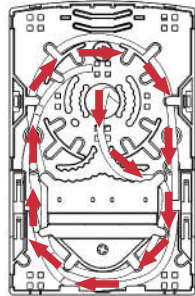
**Note:** In case that the fiber optic cable enters through the wall outlet, pass the cable through the central hole located on the base of the terminal box.

It is recommended to use 23.6~25.2in (60~64cm) of cable to have an exact routing in the direction that is shown in the manual.

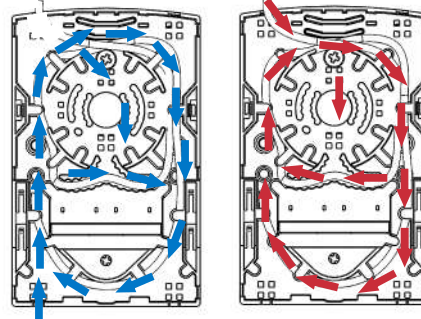
### THIRD STEP - CABLE ROUTING

Start the routing process of the cable on the base of the terminal box, with the help of the routing zones as shown in Figures 6 and 7.

**Fig.5**  
Example of the routing from the back entrance.

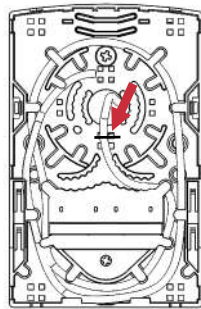


**Fig.6**  
Example of the routing from inferior or superior entrance.

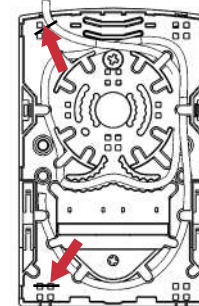


Set the drop cable with the plastic cable tie included with the kit.

**Fig.7**  
Fixing with the plastic cable tie on special grooves (back entrance).

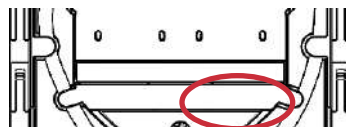


**Fig.8**  
Fixing with the plastic cable tie on special grooves (superior and inferior entrance).



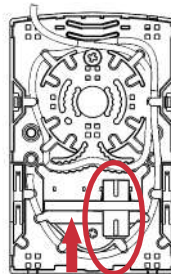
### FOURTH STEP - PLACEMENT CONNECTOR-ADAPTER

Assemble the adapter in the groove located on the terminal box, consider orientation and direction as shown in figures 10 and 11, subsequently connect the connector as shown in figure 12.

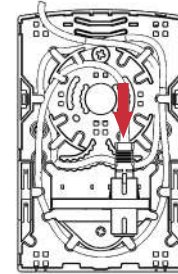


**Fig.9** Location of the grooves for the adapter.

**Fig.10**  
Adapter placed.



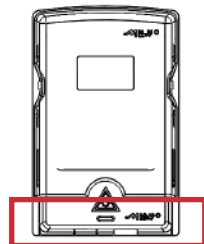
**Fig.11**  
Connector inserted in the adapter and routing zone.



### FIFTH STEP - SEALED OF TERMINAL BOX

To finish make the final assembly with the base and the top.

**Fig.12** First, locate the guides on the inferior of the base. Then, insert them through the slots at the bottom of the base.



**Fig.13** Make some pressure with the top against the base, now verify that both central pins are assembled on with the top.

