

# TERMINAL SPLICE CLOSURE

## FCLO-HO-01E-1-PFMX-SQR

### IN-LINE FIBER FTTH DROP CABLE REPAIR SPLICE CLOSURE



#### GENERAL

FUSIONGUARD® is focussed in manufacturing a complete product line of outdoor, UV rated horizontal and vertical splice closures that are resistant to water and dust and have great mechanical properties. We offer a variety of completely sealed closures for FTTH applications as well as fiber repair.

#### IP 65 RATED

<b>Solid Particle Protection IP first digit rating level: 6</b>	Totally protected against dust ingress (dust-tight).
<b>Liquid Ingress Protection IP second digit rating level: 5</b>	Protected from water jets.

#### DESCRIPTION

The In-line fiber FTTH cable repair splice closure is a unique, re-enterable, re-usable, small and easy to install IP68 rated closure that offers fusion splicing in the same closure. This product is suited for FTTH Drop cables (0.12 in x 0.08 in - 3 mm x 2 mm, ±1%) providing an ideal solution for fiber repair or quick fiber installation.

#### CHARACTERISTICS

- IP65\* rated:
  - 6: Protected from contact with harmful dust.
  - 5: Protected from water jet.
    - \*IP 68 will be met adding vulcanized tape (included).
- Lightweight, versatile and compact design.
- UV resistant (UL 746 C).
- Engineered material.
- Excellent safekeeping of fibers from harmful conditions such as dust, rain and foreign agents.
- In-line applications.

Many of our splice closures are highly configurable. If you don't see what you are looking for or have questions about our ordering matrix contained on this spec sheet please e-mail us:

[info@fusionguard.com](mailto:info@fusionguard.com)

## TECHNICAL INFORMATION

FCLO-HO-01E-1-PFMX-SQR	
Ingress Protection	IP65 (IP68 possible with vulcanized tape)
UV Resistant	Yes
Cable compatibles	0.12" x 0.08" (3 x 2)
Maximum number of fibers	1 fiber
Sealing gasket material	Engineered material
Dimensions - in (mm)	8.46" x 1.87" x 0.66" (215 x 47.5 x 16.8) ± 1%
Operating temperature	-40°F ~ +167°F (-40°C ~ + 75°C)
Color	Black
Approx Weight - lbs (g)	0.20 (92)
Tension*	3 lbf

\*Without using clamps.

## DIMENSIONS

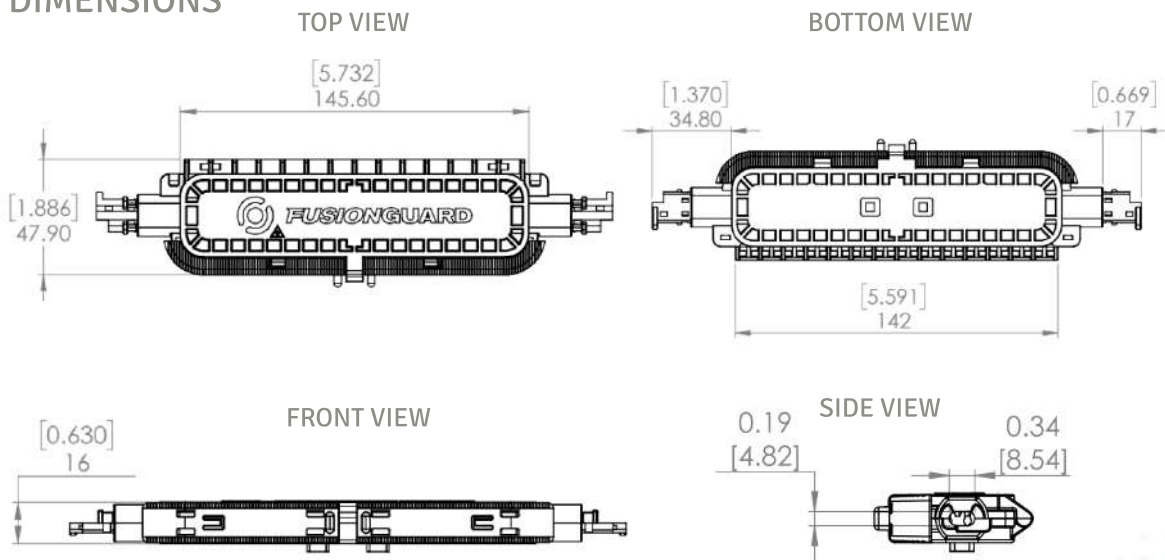

Note: Dimensions have a tolerance of ± 1%

Note: Dimensions in mm [inches]

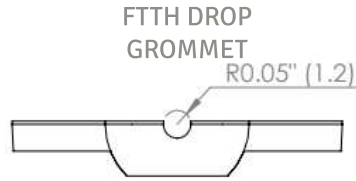

Note: Dimensions in mm [inches]

Note: Dimensions have a tolerance of ± 1%

### CONFIGURATIONS

#### FCLO-HO-01E-1-PFMX-SQR

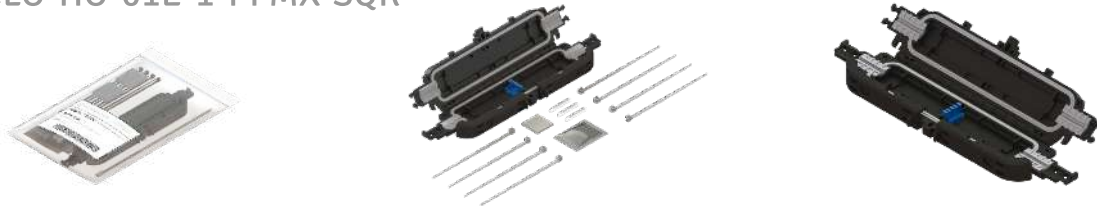

FCLO-HO-01E-1-PFMX-SQR		
FCLO-HO-01E-SQR	HORIZONTAL 1F SPLICE CLOSURE FTTH CABLE	1
FM-FO-ME-25-15	25 mm SPLICE SLEEVE WITH 1.5 mm GUIDE*	3
SSH-S4	SPLICE SLEEVE HOLDER	0.5
CN25100-NE	2.5mm x 100mm OUTDOOR PLASTIC CABLE TIE	8
FCLO-CV-20MM	VULCANIZING TAPE 20 MM X 20 MM X 2 MM	1
SG-5G	SILICONE GREASE BAG 5 GR	1

\*Splice closure designed for 1 splice. Two 25 mm splice sleeve extra included (3 pcs total).

#### FCLO-HO-01E-WKIT



FCLO-HO-01E-WKIT		
CT-13604	8"X.18" STAINLESS STEEL CABLE TIE	1
1131314	#8 X 1 1/2" ZINC PAN PHILLIPS SHEET METAL SCREW	2
5014-PE-0000-006	CLOSURE MOUNTING BASE FCLO 1	1
PEB8-38	GREY #8 X 37.5MM WALL ANCHOR	2

Note: Kit included in each configuration. Installation tools are not included.

## INSTALLATION'S METHODS

### A) AERIAL INSTALLATION

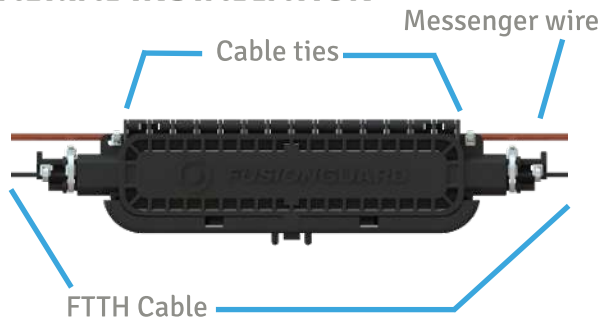

A) Aerial installation can be made with the included cable ties.

### B) AERIAL INSTALLATION

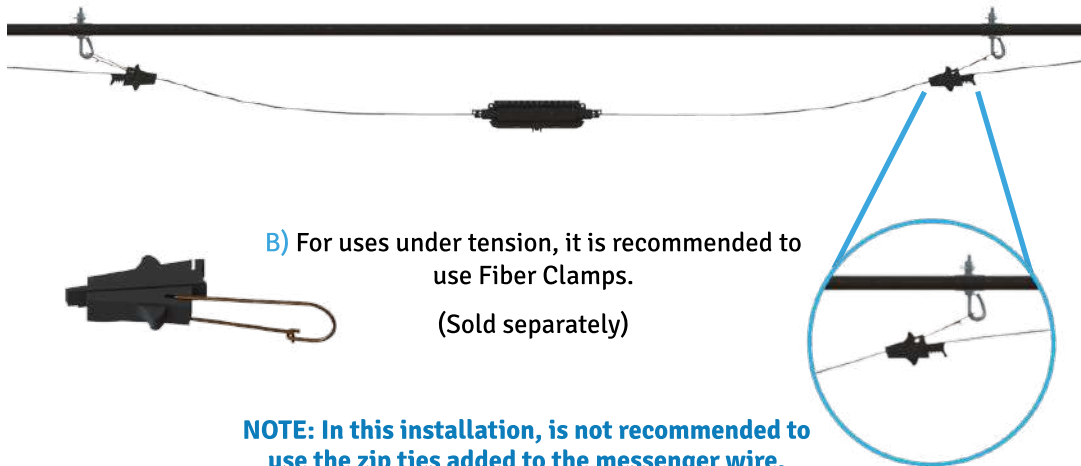

B) For uses under tension, it is recommended to use Fiber Clamps.  
(Sold separately)

**NOTE: In this installation, is not recommended to use the zip ties added to the messenger wire.**

### C) ON-FIELD APPLICATION



C) Wall mount requires the wall mount kit: FCLO-HO-01E-WKIT.  
(Included in each configuration)

### PACKAGING

One closure and a wall mount kit per packaged in a 6" x 9" plastic bag



### MOQ's

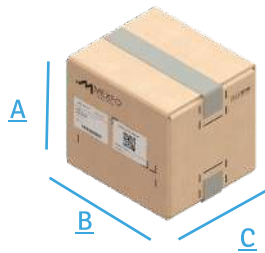

Qty. per box FONCS02-M	A in/(mm)	B in/(mm)	C in/(mm)	Approx Weight lb/(kg)
50 pieces	11.81" (300)	9.84" (250)	9.84" (250)	10.14 (4.6)

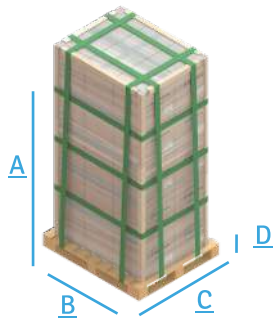

Quantity per pallet	Side A in/(mm)	Side B in/(mm)	Side C in/(mm)	Side D in/(mm)	Approx. Weight lb(kg)
3,000 pieces	82.75" (2102)	47.2" (1200)	39.4" (1000)	5.5" (140)	634.93 (288)

### LABEL SPECIFICATIONS

fusionguard.com  
info@fusionguard.com

---

**PRODUCT CODE:** FCLO-HO-01E-1-PFMX-SQR

**DESCRIPTION:**  
HORIZONTAL 1P SPLICE CLOSURE, 1 SPLICE SLEEVE PRELOAD FTTH

**QTY:** 1 PIECE

FCLO-HO-01E-1-PFMX-SQR

## ORDERING MATRIX

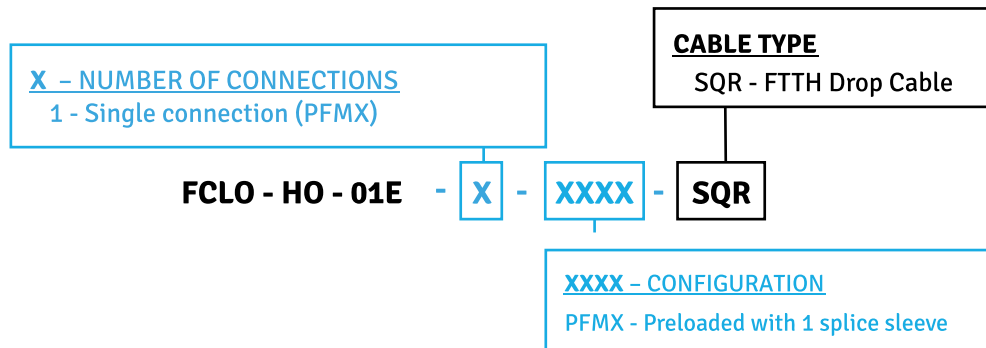

## WARNINGS

Pre-lubricated item. Avoid leaving the splice closure open.

For IP68 improvement add silicone grease at the gasket before closing it.