

6 PORT FIBER OPTIC PRO TERMINAL BOX

FWB-06P
TERMINAL BOX

The MEXFO SERV® Fiber Optic Terminal Boxes, also known as Network Interface Device (NID) which are typically used as a transition point where the OSP cable is spliced to an indoor cable. This UV resistance housing is designed for wall mount applications to provide protection for fiber optic connections and splices in indoor and outdoor environments.

MEXFO SERV® offers multiple pre-assembled terminal box options for compact fiber management on FTTX installations. It integrates fiber splicing, splitting, distribution, storage in one unit allowing the cables to be crossed and connected in a variety of ways. In addition, the Fiber Optic Terminal Box protects the fiber and provides good properties against dust & moisture.



6 Port Fiber Optic Pro Terminal Box

APPLICATIONS

- Telecommunication
- CATV
- FTTX

GENERAL CHARACTERISTICS

- Outdoor wall mounting.
- SC duplex and LC quad adapter compatible.
- Integrated lock opens with a flat-faced screwdriver.
- Outdoor resistant.
- PLC Splitter compatible.
- Outdoor/indoor cable compatible.

STANDARDS

- IP 65
- IK 7 Impact

Note: Images for reference only



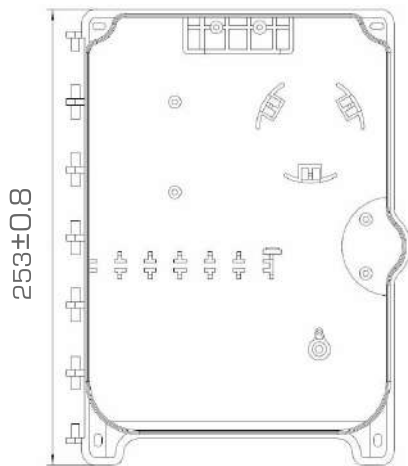
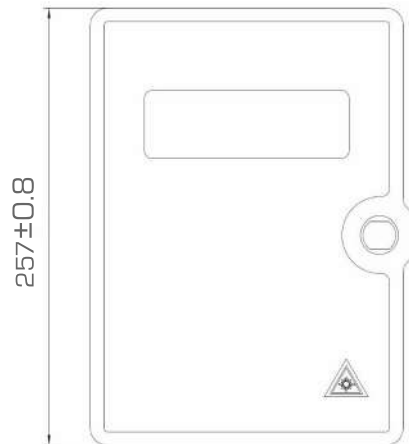
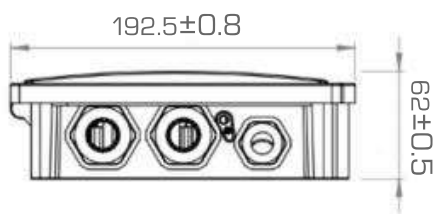
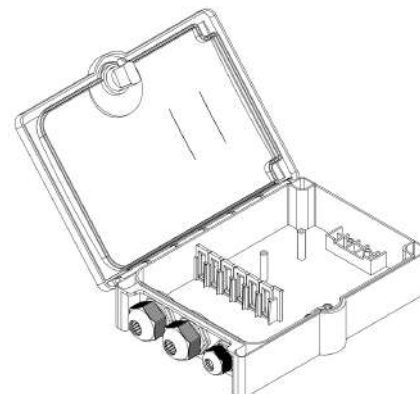

SPECIFICATIONS

SPECIFICATIONS	
3 LC quad adapters maximum capacity.	Dimensions: 257 x 192.5 x 62mm (10.1 x 7.5 x 2.4")
6 SC duplex adapters maximum capacity.	Material: PC
Grounding kit included for armored cable	Metal cable support for input cable
8.1 x 4.5mm flat drop and 4.8/3mm round cable compatible for input entrance.	9 mm - 18 mm output cable acceptance
Weight: 766 gr	Operational temperature -13°F ~ 167°F (-25°C ~ 75°C)

DIMENSIONS

Fig. 1 Top view (without cover)

Fig. 2 Top view (with cover)

Fig. 3 Side view

Fig. 4 Detailed view

Note: Illustrative images



INCLUDED COMPONENTS					
FWB-06P-EMP EMPTY 6 PORT FIBER OPTIC PRO TERMINAL BOX		FWB-06P-XX-XXX-X-X 6 PORT FIBER OPTIC PRO TERMINAL BOX PRELOADED WITH ADAPTERS		FWB-06-XX-XXX-X-X 6 PORT FIBER OPTIC PRO TERMINAL BOX PRELOADED WITH ADAPTERS & PIGTAILS	
Transition tube	2 pcs	Transition tube	2 pcs	Transition tube	2 pcs
Plastic cable ties	10 pcs	Plastic cable ties	10 pcs	Plastic cable ties	10 pcs
Screw with 1" anchor with their wall dowel	4 pcs	Screw with 1" anchor with their wall dowel	4 pcs	Screw with 1" anchor with their wall dowel	4 pcs
Pre-installed input dummy cap	1 pc	Pre-installed input dummy cap	1 pc	Pre-installed input dummy cap	1 pc
Pre-installed output dummy cap	2 pcs	Pre-installed output dummy caps	2 pcs	Pre-installed output dummy caps	2 pcs
Extra flat drop input grommet	1 pc	Extra flat drop input grommet	1 pc	Extra flat drop input grommet	1 pc
Extra grommet 8 holes for 3 mm cable	2 pcs	Extra grommet 8 holes for 3 mm round cable.	2 pcs	Extra grommet 8 holes for 3 mm round cable.	2 pcs
40 mm splice sleeves with 1.0 mm steel guide according to cable density	12 pcs	40 mm splice sleeves with 1.0 mm steel guide according to cable density	12 pcs	40 mm splice sleeves with 1.0 mm steel guide according to cable density	12 pcs
		SC duplex adapter or LC quad adapter	6 or 3 pcs	SC duplex adapter or LC quad adapter	6 or 3 pcs
				Pigatils according adapters configuration	up to 12 pcs
					

Note: Illustrative images



PACKAGING

PACKAGING SPECIFICATIONS				
PACKAGING	QUANTITY OF FWB-06P INTO A 274 x 195 x 65mm INDIVIDUAL BOX	QUANTITY OF INDIVIDUAL BOXES INTO A 490 X 184 X 482mm FONCS16-M	QUANTITY OF FONCS16-M INTO A 500 X 59 4X 500mm FONCS15-M	WEIGHT OF EVERY FONCS15-M
1	1 piece	Fit 6 individual boxes (6 pieces)	Fit 3 FONCS16-M (18 pieces)	27.32 kg/60.2 lb

PALLET SPECIFICATIONS			
1	QUANTITY OF FONCS15-M PER PALLET	TOTAL QUANTITY OF FWB-02P PER PALLET	TOTAL WEIGHT
	16 FONCS15-M into a 48X40X5.37" (1219X1016X136.53mm) standard pallet	288 pieces per pallet	437.12 kg/963.68 lb

1



Fig. 2 Individual Package



Fig. 4 FONCS16-M

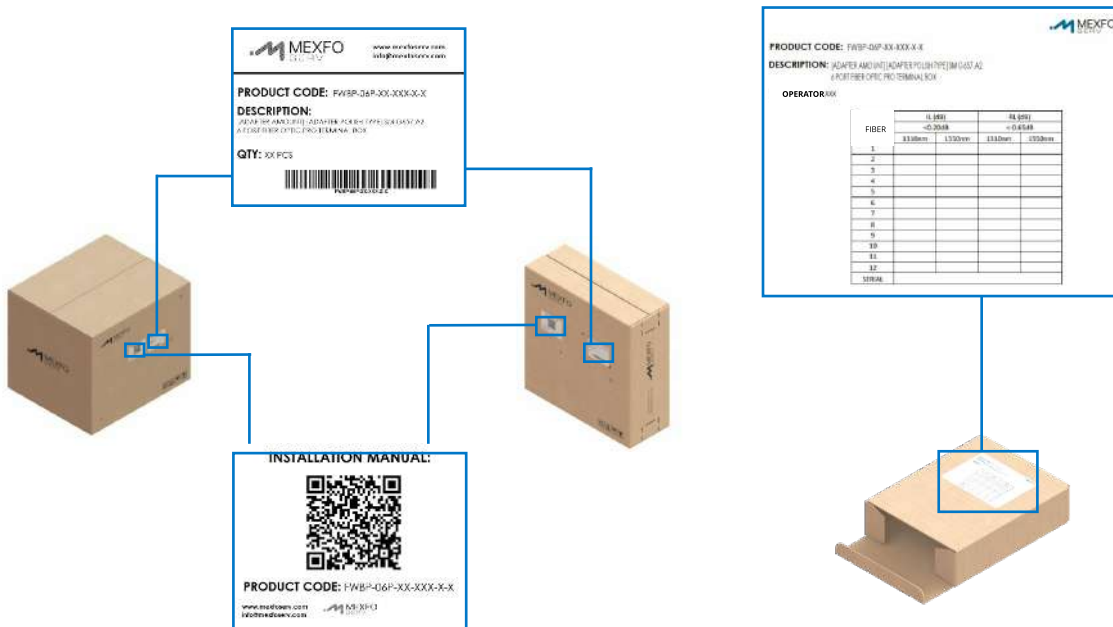

Fig. 8 FONCS15-M



Fig. 9 Pallet packaging

LABELING SPECIFICATION FOR INDIVIDUAL BOX



Note: Illustrative images



ORDERING MATRIX

EMPTY 6 PORT FIBER OPTIC PRO TERMINAL BOX

FWB – 06P – EMP

6 PORT FIBER OPTIC PRO TERMINAL BOX PRELOADED WITH THREE LC QUAD ADAPTERS

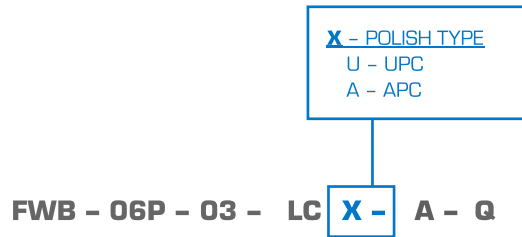

6 PORT FIBER OPTIC PRO TERMINAL BOX PRELOADED WITH SIX SC DUPLEX ADAPTERS

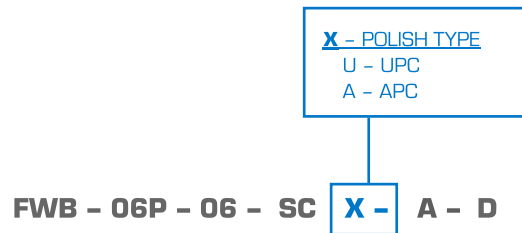

6 PORT FIBER OPTIC PRO TERMINAL BOX PRELOADED WITH ADAPTERS & PIGTAILS

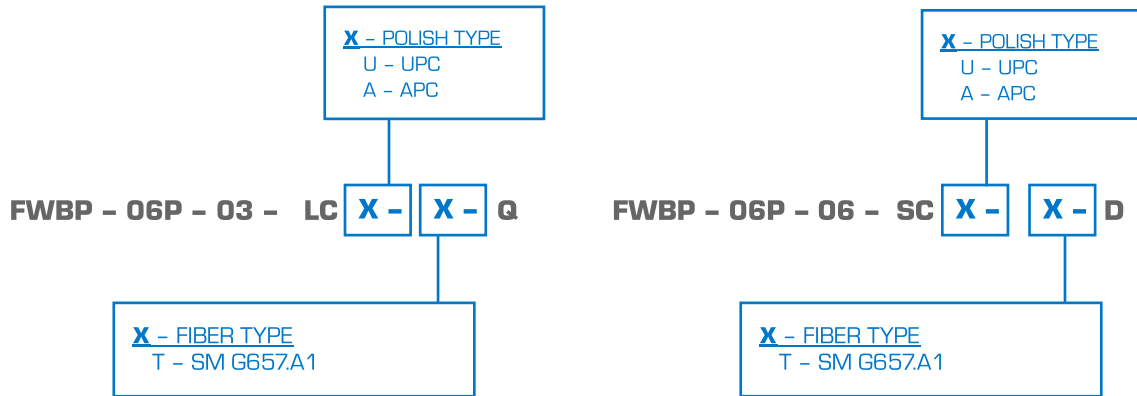

Note: The quantity and polish of the 2 meters (6.5 ft) pigtails will be the same as the adapters configuration. (12 pigtail pieces.)

Note 1: The 6 PORT FIBER OPTIC PRO TERMINAL BOX can support 12 splice sleeves only so it can be only available with 6 duplex SC adapters or 3 quad LC adapters. (The adapters will be completely preinstalled.)

Note 2: The configuration with pigtails preloaded will be differenced with a P at the end of the first part of the configurable code (FWBP)

Note 3: The 6 PORT FIBER OPTIC PRO TERMINAL BOX are highly configurable. Please contact your sales representative if you need help to configure your product or if a special pad printing is needed.

