

2 PORT WALL OUTLET TERMINAL BOX

FWB-02C
TERMINAL BOXES

The MEXFOSERV® offers a variety of desktop (wall-mountable) lightweight indoor high quality ABS Fiber Optic Terminal Boxes which are normally used as a termination point inside the home, office or apartment for the feeder cable to connect with cable in FTTX applications. It integrates fiber splicing, flexible connections and storage in one unit allowing the cables to be crossed and connected in a variety of ways. In addition, the Fiber Optic Terminal Box protects the bend radius and provides good properties against dust & moisture.

The 2 Port Wall Outlet Terminal Box is a widely customizable product. MEXFOSERV® adds the option for pad printing to include the customer logo, to be able to differentiate your product, as well as multiple preassembled options to minimize the cost of installation, allowing an easy, fast & unobtrusive termination in an office, home or communications room.



2 Port Wall Outlet Terminal Box

APPLICATIONS

- FTTX
- Indoor applications

GENERAL CHARACTERISTICS

- Indoor wall-mount
- SX SC adapter compatible
- DX LC adapter compatible
- Access to drop cable: vertical input/output.
- The lid has an "auto-clip" mechanism, making it easier to open & close.
- Includes mounting accessories
- Material: ABS flame retardant.
- White color.
- Impact resistance class IK 9 rated
- UL 94 V-0



Note: Images for reference only



SPECIFICATIONS

SPECIFICATIONS	
Maximum capacity: 2 adapters	Dimensions: 83x129.5x23.9mm (3.2x5x0.9")
DX LC adapter compatible	Operational temperature: -40°C a 70°C
Weight: 57.5g ± 5%	Material: ABS
Capacity to store up to four 45mm (1.57") splice sleeves with a 1.5mm (0.047") steel guide.	Compatible with square drop cable (3x2mm / 0.11x0.078"), 3mm (0.11") and 5mm (0.19") round cables
IP Grade: IP55	Wall width: 1.5mm (0.59") +- 0.1mm (0.004")
Available for UPC & APC polished connectors	Color: White
Available preloaded fibers: SM G657.A1 & SM G657.A2	Capacity to store 40cm of 5mm round cable, 1m of 3mm round cable or 10m of 900um cable

DIMENSIONS

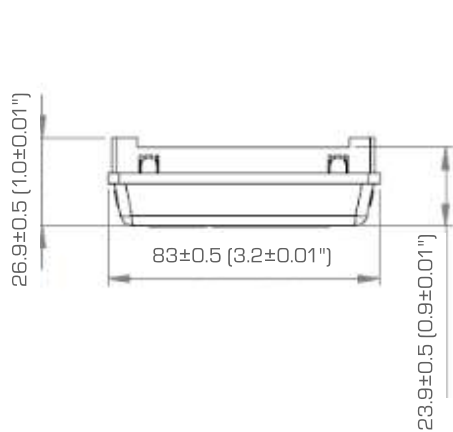

Fig. 2 Top view

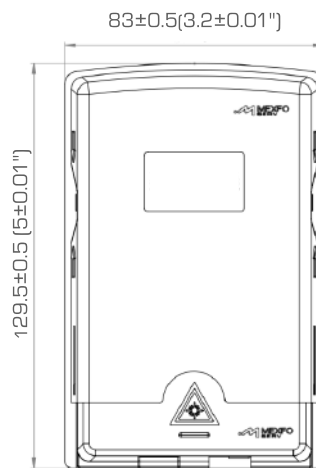

Fig. 3 Front view

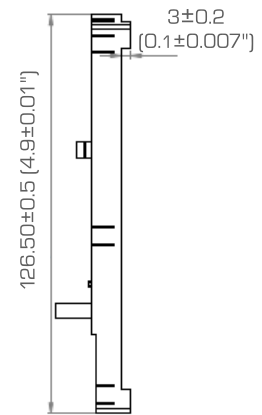

Fig. 4 Side view

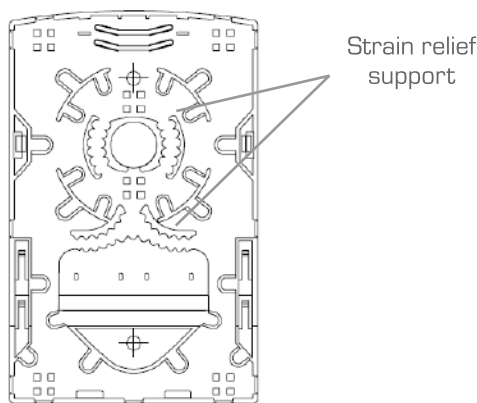

Fig. 5 Main base front view

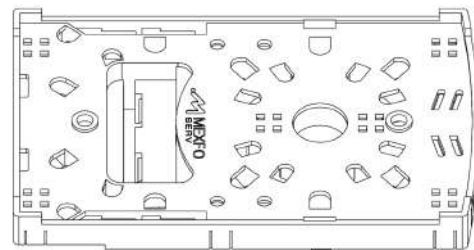







Fig. 6 Side view

Note: All dimensions established in mm and inches.



INCLUDED COMPONENTS					
FWB-02C-EMP EMPTY 2 PORT WALL OUTLET TERMINAL BOX		FWB-02C-XX-XXX-A-X 2 PORT WALL OUTLET TERMINAL BOX PRELOADED WITH ADAPTERS		FWBP-02C-XX-XXX-X-X 2 PORT WALL OUTLET TERMINAL BOX PRELOADED WITH ADAPTERS & PIGTAILS	
1 pc	Wall mount box	1 pc	Wall mount box	1 pc	Wall mount box
2 pcs	80 x 2.5mm (3.15X0.09") cable tie	2 pcs	80 x 2.5mm (3.15X0.09") cable tie	2 pcs	80 x 2.5mm (3.15X0.09") cable tie
2 pcs	Splice tray fixing screw	2 pcs	Splice tray fixing screw	2 pcs	Splice tray fixing screw
2 pcs	#8 x1 1/2 screw	2 pcs	#8 x1 1/2 screw	2 pcs	#8 x1 1/2 screw
2 pcs	#8 x 37.5mm (0.31X1.47") wall anchor	2 pcs	#8 x 37.5mm (0.31X1.47") wall anchor	2 pcs	#8 x 37.5mm (0.31X1.47") wall anchor
2 pcs	45mm (1.77") splice sleeve with 1.5mm (0.06") steel guide	Adapters according to configuration		Adapters according to configuration	
 		2 pcs	45mm (1.77") splice sleeve with 1.5mm (0.06") steel guide	2 pcs	45mm splice sleeve with 1.5mm steel guide
		 		Pigtails according to configuration	
				 	
<p>Note: Installation tools not included</p> <p>Note: [1] Terminal box goes with adapters & pigtails inside (according to configuration)</p> <p>Note: [2] Terminal box ready to ship</p> <p>Note: Wall mount box will be inside of a zipper bag [1126] Screw and wall anchors will be inside of one zipper bag [1120]</p>					



PACKAGING

PACKAGING TYPE	
Individual	Wall mount terminal box inside a 5x7" zipper bag (90 gr).
72 pieces	Individual packages inside a 387 x 238 x 389mm (15.24 x 9.37 x 15.35") EM-1030A-M carton box (6.94 kg).
PALLET PACKAGING	
Pallet	Standard pallet 1x1.2 mts.
Maximum capacity	5 beds with 12 boxes in each bed, 60 EM-1030A-M boxes in total on the pallet, protected by stretch wrap, strapping and corner protectors. (417 kg total weight) 1.02 x 1.96 x 1.2 m



Individual package



EM-1030A-M box



Pallet packaging

LABELING SPECIFICATION



EM-1030A-M box



Individual package

Note: The weight of each individual wall mount box is based on the configuration FWB-02C-XX-XXX-X-X



ORDERING MATRIX

EMPTY 02 PORT WALL OUTLET TERMINAL BOX

FWB - 02C - EMP

02 PORT WALL OUTLET TERMINAL BOX PRELOADED WITH ADAPTERS

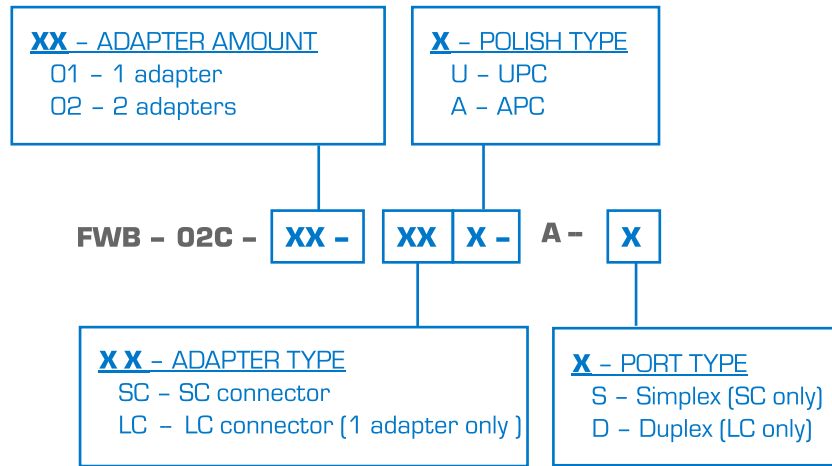

02 PORT WALL OUTLET TERMINAL BOX PRELOADED WITH ADAPTERS & PIGTAILS

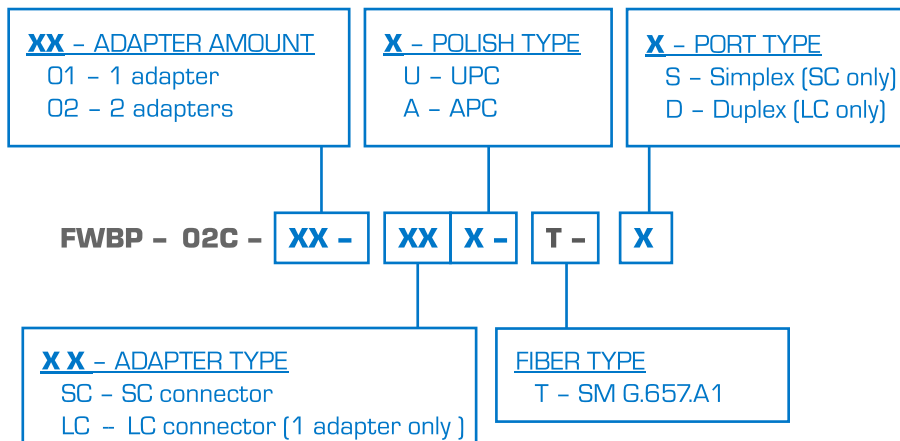

Note: Preassembled parts are highly configurable. Please contact your sales representative if you need help to configure your product or if a special pad printing is needed.

Note: In 2 Port Wall Outlet Terminal Box preloaded with adapters and pigtails, the 2 meters (6.5 ft) pigtail will be included to match adapter configuration.

